

# ACCESSORIES

N L S

## TABLE LEGS

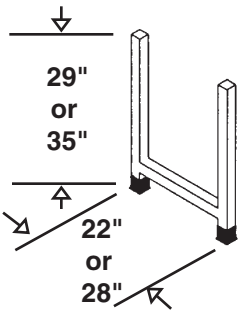

L29-22  
L35-22  
L29-28  
L35-28

## SINGLE LEG



SL-29  
SL-35

## SINGLE LEG WITH PLATE



SL-29P  
SL-35P

## END PEDESTAL

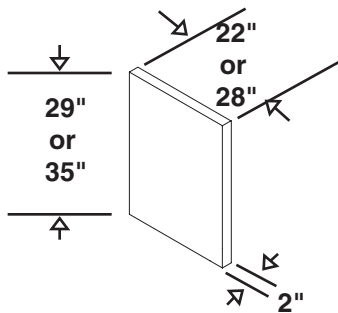

EP2902-22  
EP3502-22  
EP2902-28  
EP3502-28

## WALL CASE FRONT FILLER

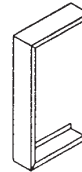

Specify Width  
WCCF24-W  
WCCF30-W  
WCCF36-W  
WCCF48-W

## WALL CASE CORNER FILLER

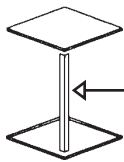

Specify Depth  
13" or 16"  
WCCF24  
WCCF30  
WCCF36  
WCCF48

Angle is 1"

## REAGENT SHELF UPRIGHT

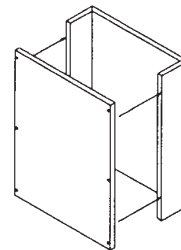

RSU1812  
(18"Hx12"Dx2"W)

Note: Special heights & options available upon request. Drawings and dimensions must accompany order.

## WALL - FLOOR CASE SHELF

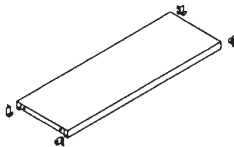

## PART NUMBERS

| WALL   | FLOOR  |
|--------|--------|
| WS1813 | FS1816 |
| WS2413 | FS2416 |
| WS3013 | FS3016 |
| WS3613 | FS3616 |
| WS4213 | FS4216 |
| WS4813 | FS4816 |
| WS1816 | FS1821 |
| WS2416 | FS2421 |
| WS3016 | FS3021 |
| WS3616 | FS3621 |
| WS4216 | FS4221 |
| WS4816 | FS4821 |

## SLOPE TOP WITH END CAPS

## PART NUMBERS

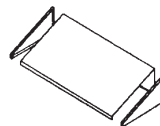

|         |         |
|---------|---------|
| ST13-18 | ST21-18 |
| ST13-24 | ST21-24 |
| ST13-30 | ST21-30 |
| ST13-36 | ST21-36 |
| ST13-42 | ST21-42 |
| ST13-48 | ST21-48 |
| ST16-18 |         |
| ST16-24 |         |
| ST16-30 |         |
| ST16-36 |         |
| ST16-42 |         |
| ST16-48 |         |

NOTE: When ordering units with configurations that are non-standard, drawings must accompany order.

# ACCESSORIES

## KNEE SPACE PANELS

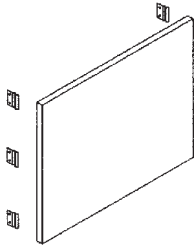

For use in sit down situation with apron

### 24" HIGH

- KSP 2424
- KSP 2430
- KSP 2436
- KSP 2442
- KSP 2448
- KSP 2454
- KSP 2460
- KSP 2466
- KSP 2472

For use in standing situation with apron, or sit down without apron

### 29" HIGH

- KSP 2924
- KSP 2930
- KSP 2936
- KSP 2942
- KSP 2948
- KSP 2954
- KSP 2960
- KSP 2966
- KSP 2972

For use in standing situation without apron

### 35" HIGH

- KSP 3524
- KSP 3530
- KSP 3536
- KSP 3542
- KSP 3548
- KSP 3554
- KSP 3560
- KSP 3566
- KSP 3572

S  
L  
N

# FILL PANELS

All base cabinet fillers are 35" high. Fillers for 29" high (low base) cabinets will need to be trimmed by the installer. Other sizes available upon request.



**C-FILLER**  
CF35-8  
CF35-14



**L-FILLER**  
LF35-1  
LF35-7  
LF35-11

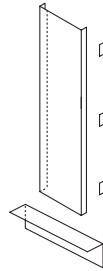

**C-FRONT FILLER**  
FFC35-8  
FFC35-14

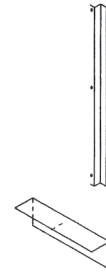

**CORNER FILLER**  
ICF35-1  
ICF35-2  
ICF35-4

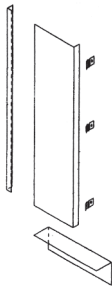

**L-FRONT FILLER**  
FFL35-8  
FFL35-14



**FLOOR CASE FILLER**  
FFL84-2  
FFL84-8

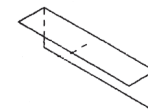

**TOE SPACE FILLER**  
TSF-00

\* Last number(s) in filler designation indicates width of filler assembly.